

## SW / BW

### Plug valves with weld ends

DIN-EN: DN 10 - 500 / PN 10 - 100

ASME: NPS 3/8" - 24" / class 150 - 600

PT range:  $-30 < T < 230/280^{\circ}\text{C}$ , vacuum 10-8 mbar



### Design Features

#### Design Characteristics

- available with butt weld and socket weld ends
- free of cavities
- maintenance free - self lubricating
- mounting-flange for actuators acc. to DIN ISO 5211
- easy accessible adjustment of the plug, even with mounted actuator
- vacuum tight
- fugitive emission resp. clean air act certified (TA - Luft 2002 approval)
- Directive 2014/68/EU
- fire safe design API 607 / ISO 10497
- FDA conformity

## PT-Diagram

General Pressure-Temperature-Diagram

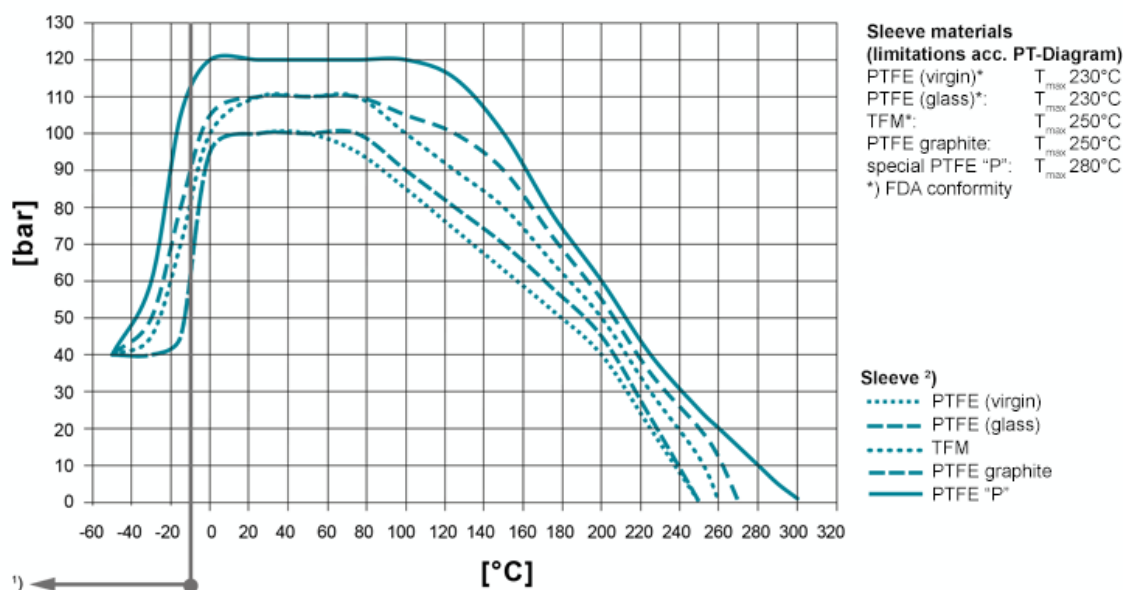

**Operating temperatures < -30°C and > 220 °C have to be checked and approved by AZ according to the operating conditions.** Besides the P/T value of the sleeve the limitations of the valve bodies also have to be considered. Please refer to the EN 12516-1 resp. ASME B16.34 in order to choose a proper pressure rating (PN/class). The shown values refer to austenitic stainless steel 1.4408 (A351 Gr. CF8M). 1) For operating temperatures below -10°C low temperature / austenitic steels are required. 2) Sleeve: There are different sleeve materials / compounds available.

## Materials

### Standard body materials

- Carbon Steel 1.0619, ASTM A216 WCB
- Stainless Steel 1.4408, ASTM A351 CF8M
- Stainless Steel 1.4308, ASTM A351 CF8
- Unalloyed stainless steel casting (low Temp.) 1.1138, LCC/LCB/A352 **Standard plug materials**
- Stainless Steel 1.4408, ASTM A351 CF8M
- Stainless Steel 1.4308, ASTM A351 CF8 **Special materials**

- Alloy
- Monel
- Nickel
- Zirconium
- Titan
- Tantal
- other materials on request

## Sealing Systems

Standard sealing for all major applications;

T<sub>max</sub> 230°C

### Type STD

[read more \[...\]](#)

Firesafe sealing (API 607) with graphite packing for additional stem sealing; T<sub>max</sub> 230°C

### Type FS

[read more \[...\]](#)

Chemical sealing to prevent fugitive emission of aggressive and toxic media with PTFE packing for additional stem sealing;

T<sub>max</sub> 230°C

### Type CA

[read more \[...\]](#)

Firesafe safety sealing (API 607) for fluctuating temperatures with 3x graphite packing (adjustable) for additional stem sealing; T<sub>max</sub> 280°C

### Type FSN

[read more \[...\]](#)

Firesafe safety sealing (API 607) for fluctuating temperatures with 3x graphite packing (live loaded disc springs) for additional stem sealing; T<sub>max</sub> 280°C

### Type FSN-SL

[read more \[...\]](#)

Chemical safety sealing for fluctuating temperatures with 3x PTFE packing (adjustment) for additional stem sealing;

T<sub>max</sub> 230°C

### Type CASN

[read more \[...\]](#)

Chemical safety sealing for fluctuation temperatures with 3x PTFE packing (live loaded disc springs) for additional stem sealing; T<sub>max</sub> 230°C

### Type CASN-SL

[read more \[...\]](#)

## Port Forms



AZ plug valves are fitted with cast, rust proof position indicators. The position indicator is securely welded to the plug to prevent it from working loose.

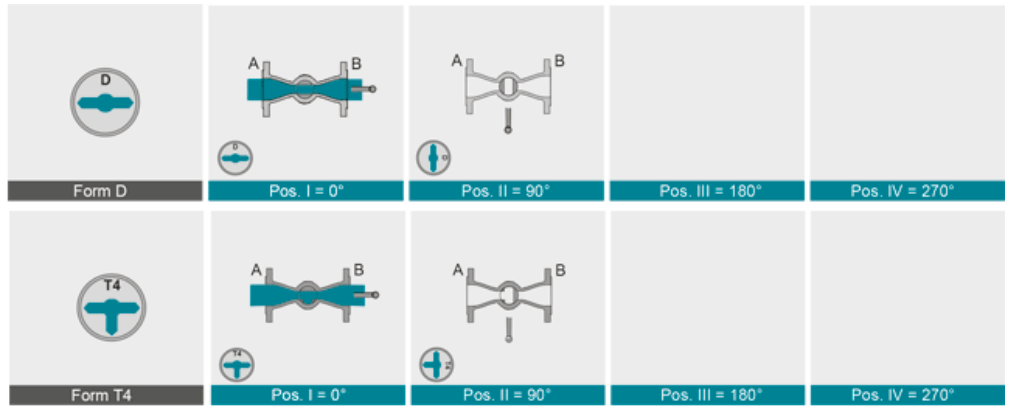
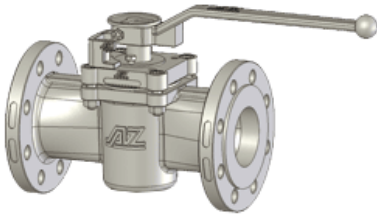
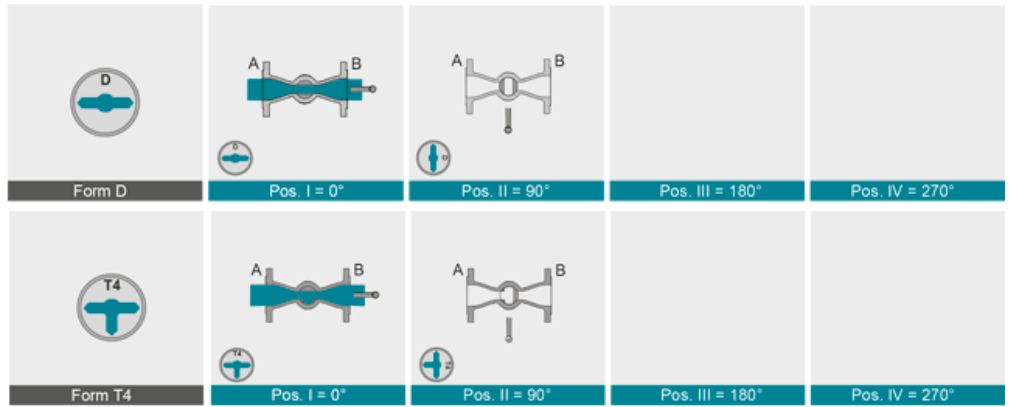
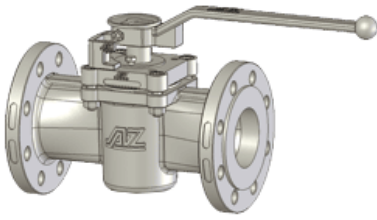

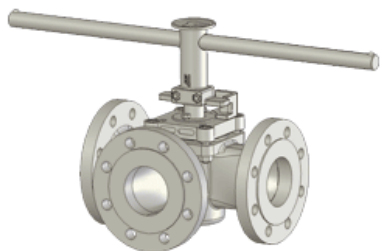
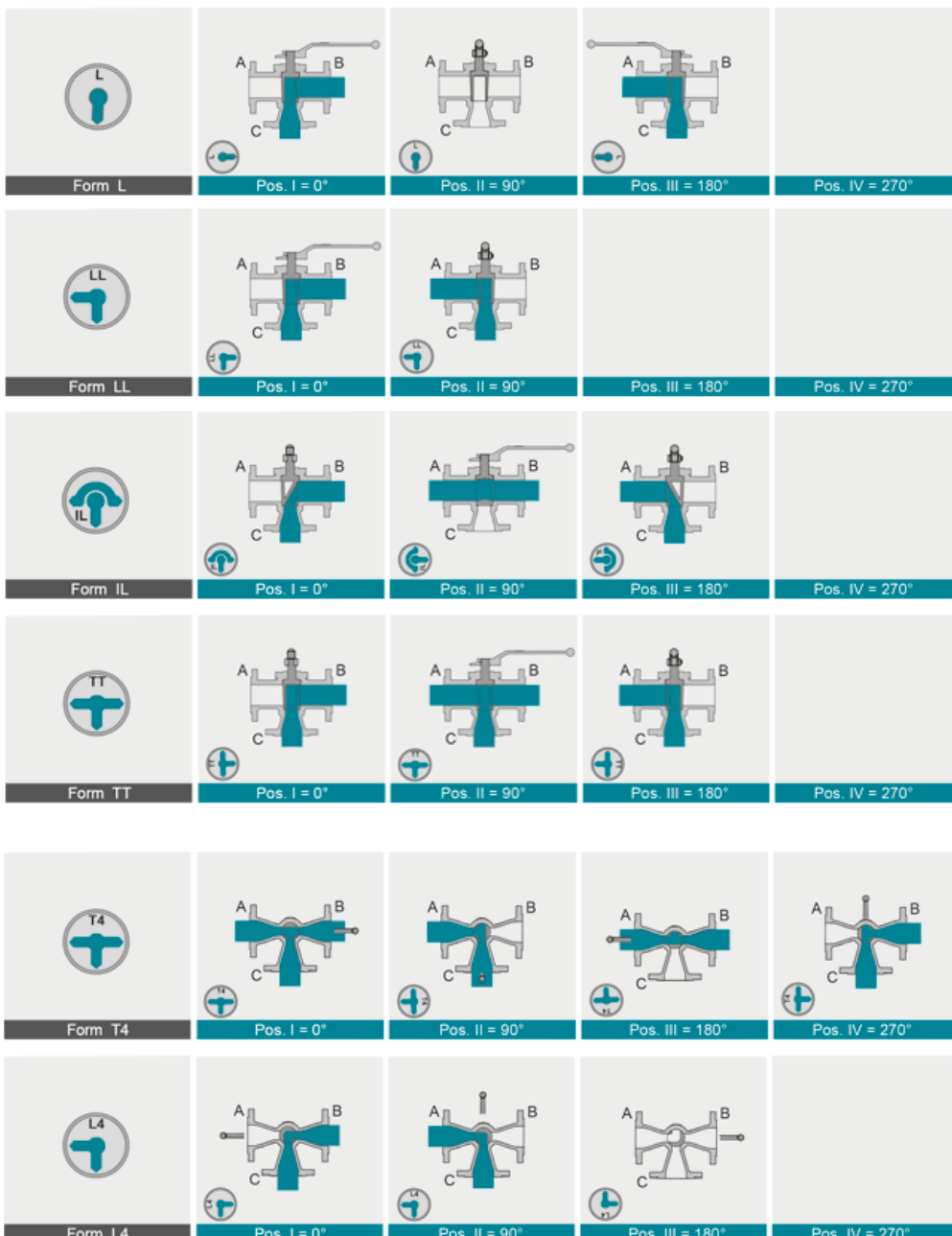
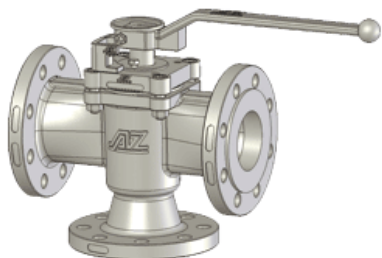

others on request

## Technische Daten

Typ

BW

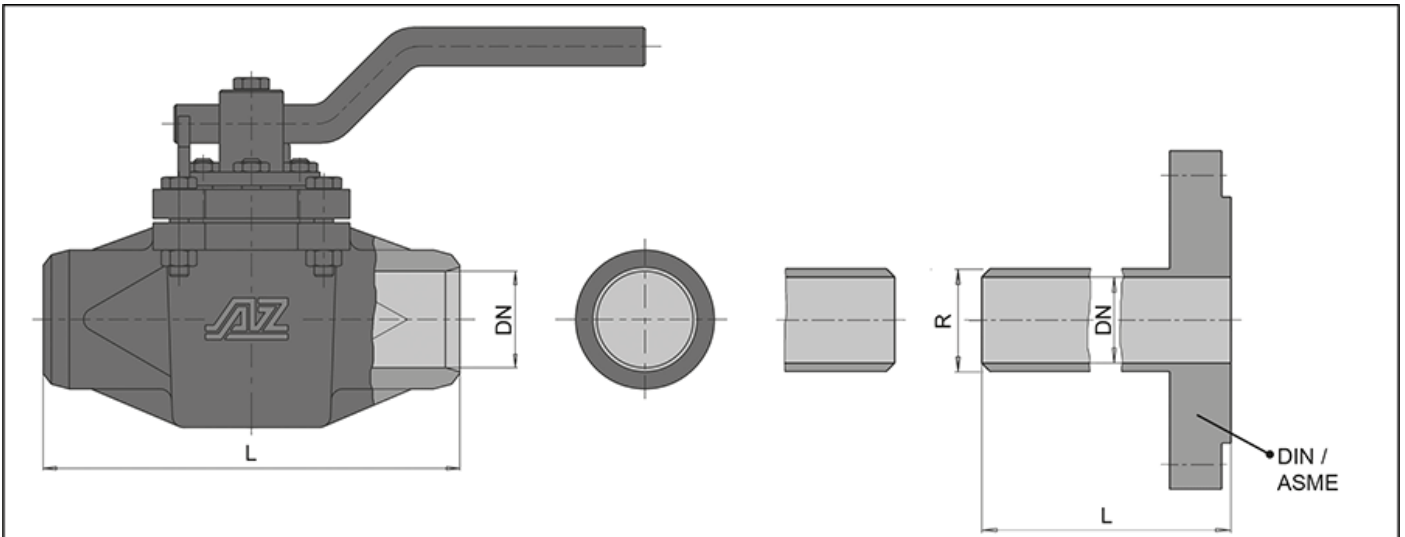

	DN			L*		R*		
	DIN	ANSI		DIN	ANSI	DIN	ANSI	
Buttwelding Ends	10	3/8"		165	130	18	18	
	15	1/2"		165	140	22	22	
	20	3/4"		165	152	28	28	
	25	1"		165	165	35	35	
	32	1 1/4"		180	178	44	44	
	40	1 1/2"		200	190	50	50	
	50	2"		230	216	62	62	
	65	2 1/2"		290	241	77	77	
	80	3"		310	283	91	91	
	100	4"		350	305	117	117	
	125	5"		325	381	144	144	
	150	6"		432	403	172	172	
	200	8"		508	419	223	223	
	250	10"		450	450	278	278	
	300	12"		500	500	329	329	
	350	14"		550	550	362	362	
400	16"		600	600	413	413		
450	18"		650	650	464	464		
500	20"		700	700	516	516		

Typ

SW

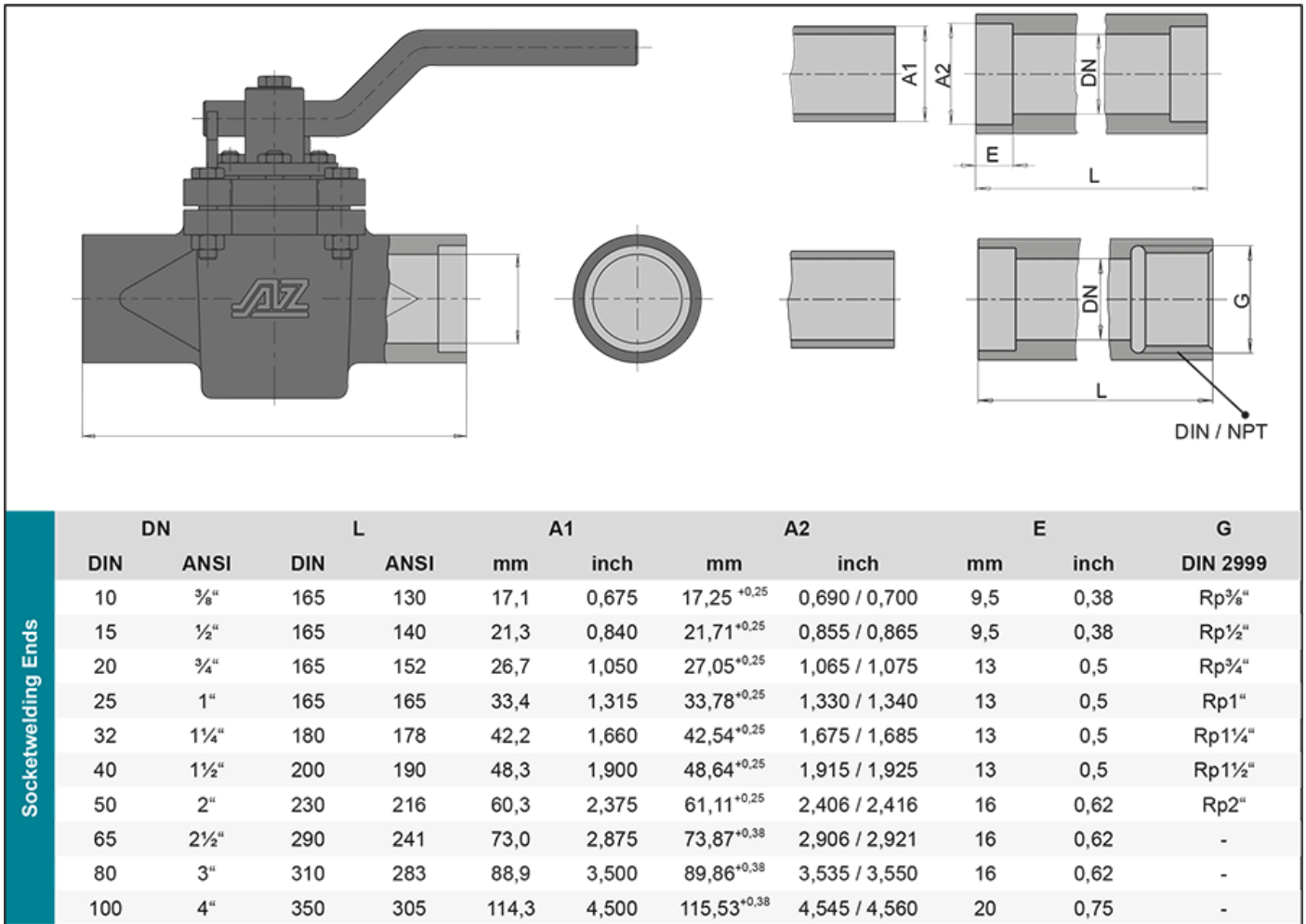

## Actuation

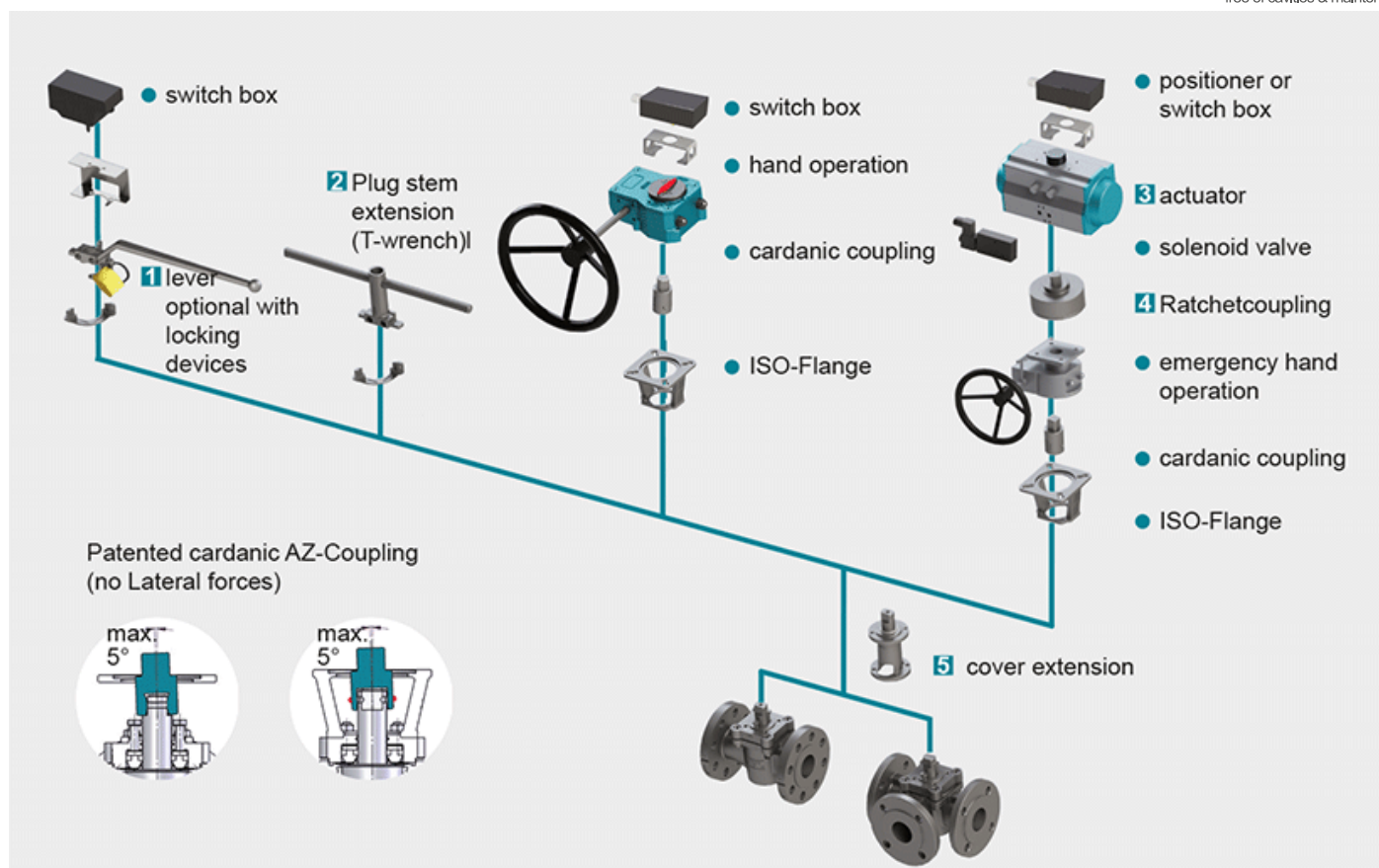

### 1 Locking Devices

Pilot valve combinations, pad lock eyelets, linear key conception, indexing plunger arrestor.

### [read more \[...\]](#) 2 Plug stem extension

Solid construction in stainless steel with T-wrench, Standard extension 100 mm or 150 mm, non standard lengths are available on request

### [read more \[...\]](#) 3 Actuators

Actuators for mounting-flange acc. to DIN ISO 5211

[read more \[...\]](#) NEW: Pneumatic actuator AIR GEAR for plug valves with high torque  $\geq 150.000$  Nm

### [read more \[...\]](#) 4 Ratched coupling

To usw on multiport valves with standard 90° actuator for bigger switchpositions than 90°

### [read more \[...\]](#) 5 Cover extension

Solid construction in stainless steel, Standard extension 100 mm or 150 mm high, non standard lengths are available on request . Hexagonal bolts on adjustment ring freely accessible. Note: Don't use with sealing FSN/FSN-SL and CASN/CASN-SL

[read more \[...\]](#)