

DBI

Plug Valve Double Block & Bleed Inspection

- “double block & bleed” with only one valve
- reliable and tight

DN 25 – 600 / PN 10-40
NPS 1 – 24 / Class 150-300



Reliably Working for our Customers

Industries

Storage • Refinery • Transport • Energy

Media

Oil • Gas • Jet fuel • Diesel • Sulfuric acid • Chlorine oxide ClO₂

Functional Principle

- AZ plug valves with two self-sealing elements Block 1 and Block 2
- Closing of the plug valve seals off Block 1 and Block 2

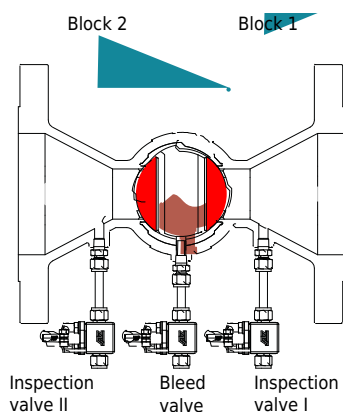

- Open the bleed valve for tightness testing
- Inspection and revision services using inspection valves I+II

Design Features

Design Characteristics

- PTFE-sleeved plug for large sealing surface - reliable and tight
- “double block & bleed” possible with only one valve
- suitable for critical service
- long durability - adjustable plug
- outlet positions customized
- cost saving compared to 2 valve system
- alternative to traditional “lift and turn” plug valves
- Firesafe acc. to API 607 / ISO 10497 (only externally)
- TA - Luft approval

PT-Diagram

General Pressure-Temperature-Diagram

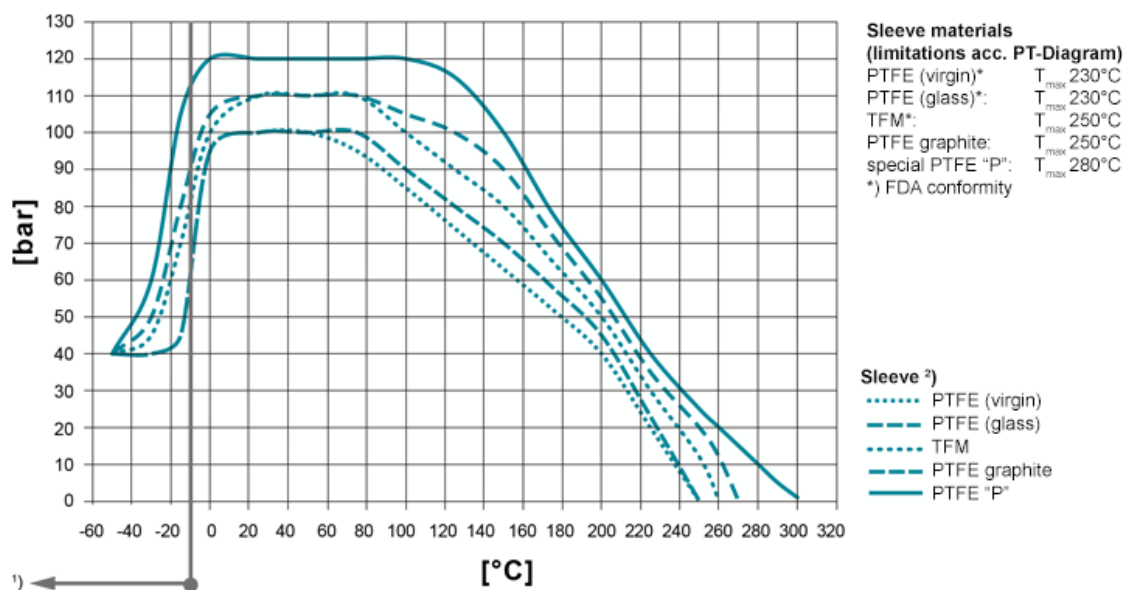

Operating temperatures < -30°C and > 220 °C have to be checked and approved by AZ according to the operating conditions. Besides the P/T value of the sleeve the limitations of the valve bodies also have to be considered. Please refer to the EN 12516-1 resp. ASME B16.34 in order to choose a proper pressure rating (PN/class). The shown values refer to austenitic stainless steel 1.4408 (A351 Gr. CF8M). 1) For operating temperatures below -10°C low temperature / austenitic steels are required.

2) Sleeve: There are different sleeve materials / compounds available.

Materials

Standard body materials

- Carbon Steel 1.0619, ASTM A216 WCB
- Stainless Steel 1.4408, ASTM A351 CF8M
- Stainless Steel 1.4308, ASTM A351 CF8
- Unalloyed stainless steel casting (low Temp.) 1.1138, LCC/LCB/A352
- Stainless Steel 1.4408, ASTM A351 CF8M
- Stainless Steel 1.4308, ASTM A351 CF8

Standard plug materials

- Alloy
- Monel
- Nickel
- Zirconium
- Titan
- Tantal
- other materials on request

Sealing Systems

Standard sealing for all major applications;

T_{max} 230°C

Type STD

[read more \[...\]](#)

Firesafe sealing (API 607) with graphite packing for additional stem sealing; T_{max} 230°C

Type FS

[read more \[...\]](#)

Chemical sealing to prevent fugitive emission of aggressive and toxic media with PTFE packing for additional stem sealing;

T_{max} 230°C

Type CA

[read more \[...\]](#)

Firesafe safety sealing (API 607) for fluctuating temperatures

with 3x graphite packing (adjustable) for additional stem sealing; T_{max} 280°C

Type FSN

[read more \[...\]](#)

Firesafe safety sealing (API 607) for fluctuating temperatures

with 3x graphite packing (live loaded disc springs) for additional

stem sealing; T_{max} 280°C

Type FSN-SL

[read more \[...\]](#)

Chemical safety sealing for fluctuating temperatures with 3x PTFE packing (adjustment) for additional stem sealing;

T_{max} 230°C

Type CASN

[read more \[...\]](#)

Chemical safety sealing for fluctuation temperatures with 3x PTFE packing (live loaded disc springs) for additional

stem sealing; T_{max} 230°C

Type CASN-SL

[read more \[...\]](#)

Port Forms

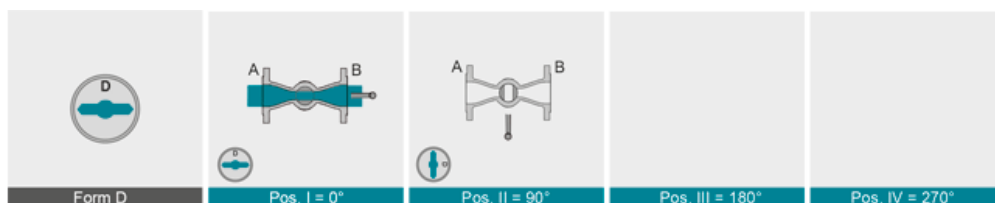

Dimensions

The valve type DBI is available in all common sizes acc. to DIN / ASME

Actuation

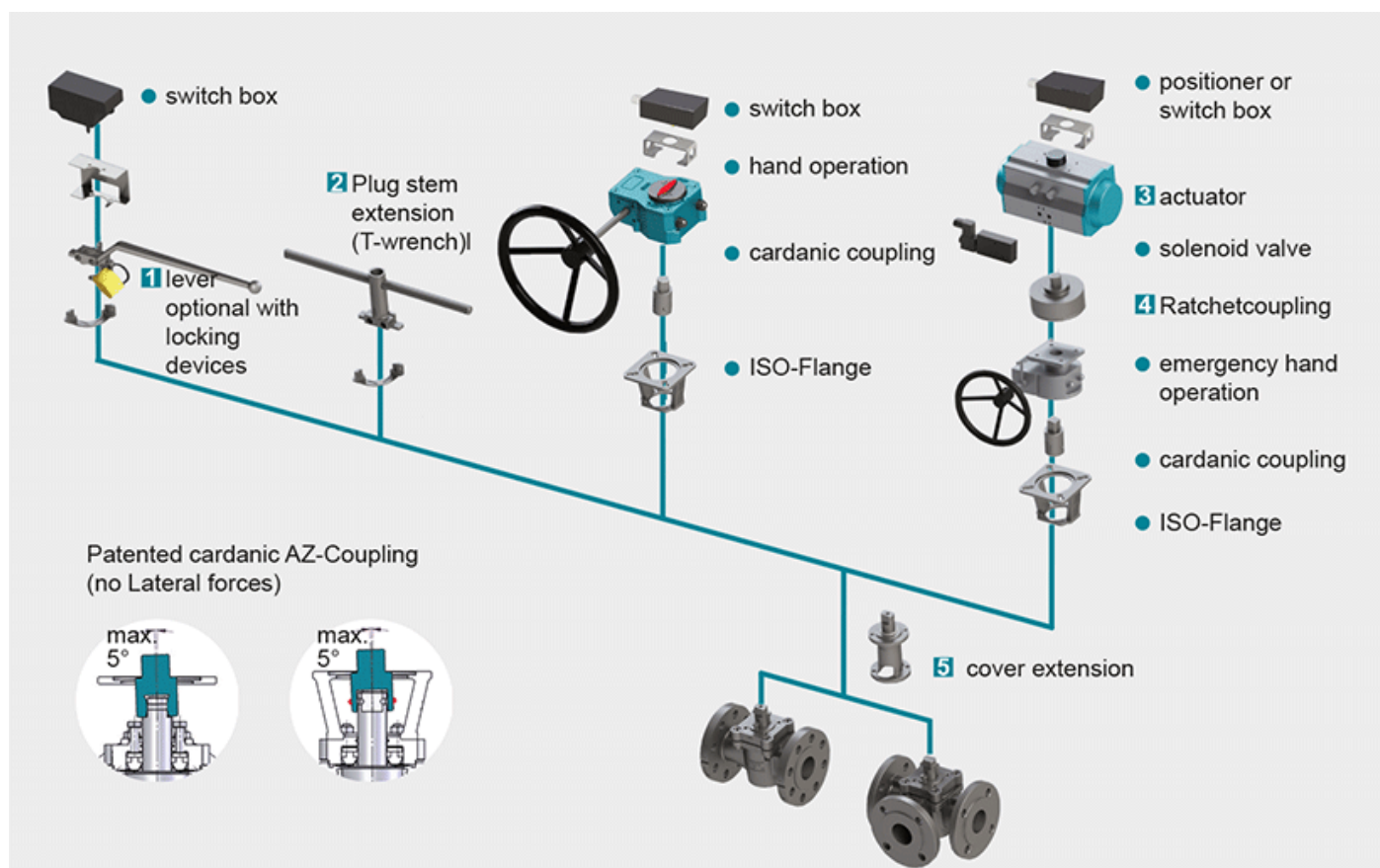

1 Locking Devices

Pilot valve combinations, pad lock eyelets, linear key conception, indexing plunger arrestor.

[read more \[...\]](#) 2 Plug stem extension

Solid construction in stainless steel with T-wrench, Standard extension 100 mm or 150 mm, non standard lengths are available on request

[read more \[...\]](#) 3 Actuators

Actuators for mounting-flange acc. to DIN ISO 5211

[read more \[...\]](#) NEW: Pneumatic actuator AIR GEAR for plug valves with high torque =150.000 Nm

[read more \[...\]](#) 4 Ratched coupling

To usw on multiport valves with standard 90° actuator for bigger switchpositions than 90°

[read more \[...\]](#) 5 Cover extension

Solid construction in stainless steel, Standard extension 100 mm or 150 mm high, non standard lengths are available on request . Hexagonal bolts on adjustment ring freely accessible. Note: Don't use with sealing FSN/FSN-SL and CASN/CASN-SL

[read more \[...\]](#)

Product Range

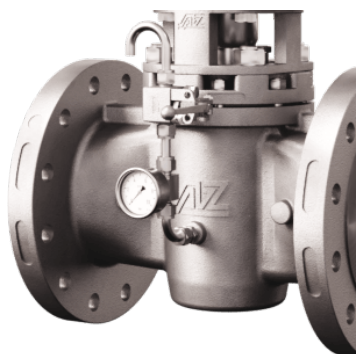

DBI-B

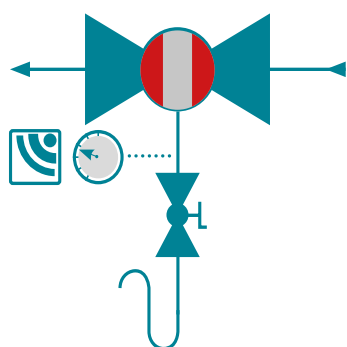

- bleed valve to check tightness when main valve is closed
- bleed outlet standard with "goose neck" pipe

Accessories:

- bleed outlet standard with "goose neck" pipe
- pressure transmitter
- valve automation
- locking device

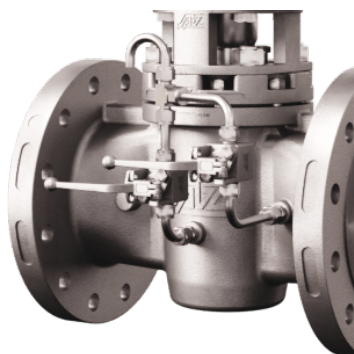

DBI-B&I

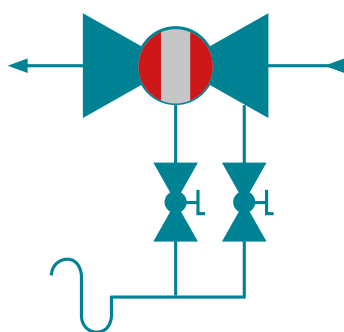

- bleed valve to check tightness when main valve is closed
- inspection valve for inspection and revision services

Accessories:

- manometer/pressure gauge
- pressure transmitter
- valve automation
- locking device

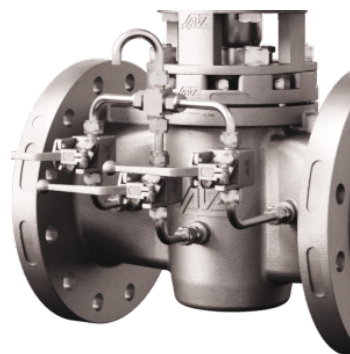

DBI-B&2I

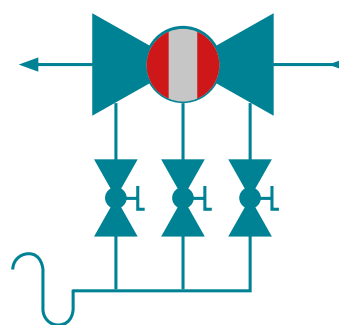

- bleed valve to check tightness when main valve is closed
- inspection valve I and II (upstream / downstream) for inspection and revision services

Accessories:

- manometer/pressure gauge
- pressure transmitter
- valve automation
- locking device

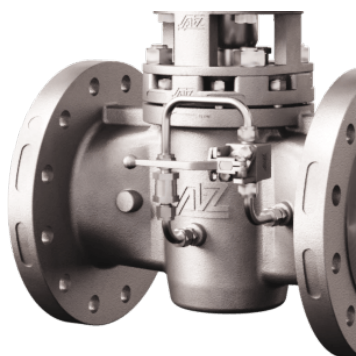

DBI-TR1

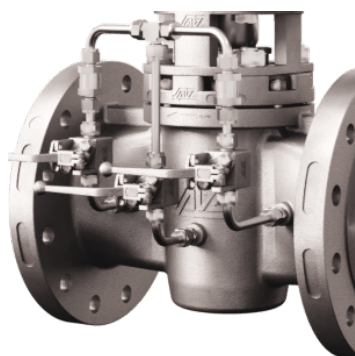

DBI-TR2

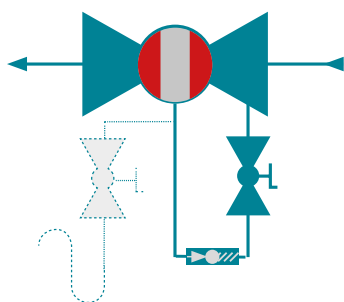

- thermal relief system to prevent pressure build-up due to thermal expansion in the plug
- isolation valve in case of service

Accessories:

- bleed valve
- manometer/pressure gauge
- pressure transmitter
- valve automation
- locking device

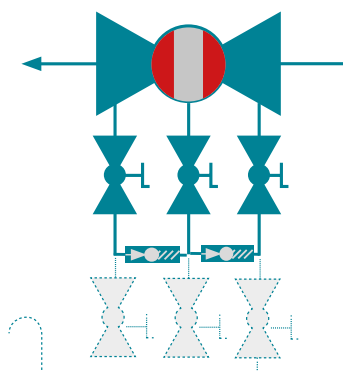

- thermal relief system to prevent pressure build-up due to thermal expansion in the plug and downstream pipeline
- isolation valves in case of service

Accessories:

- bleed valves
- inspection valves
- manometer/pressure gauge
- pressure transmitter
- valve automation
- locking device